

Suggestions For Installing the QuadraBag System

By Bill Brown

The QuadraBag system for the rear suspension on Classic 1973 – 1978 GMC motorhomes was designed by Jim Bounds and Jim Kanomata and has many advantages over the factory dual bag system. This publication is a collection of suggestions of installation procedures based on a combination of the instructions provided with the kit and my observations and experience when installing the kit on my personal 1977 coach. It is my hope that readers will find this information useful and informative. A copy of the instructions that came with the kit is attached.

For additional questions or concerns please call Applied GMC at 1 (800) 752-7502.

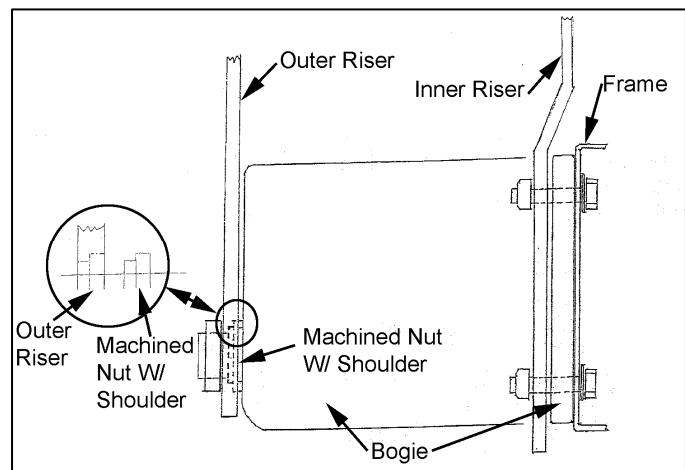
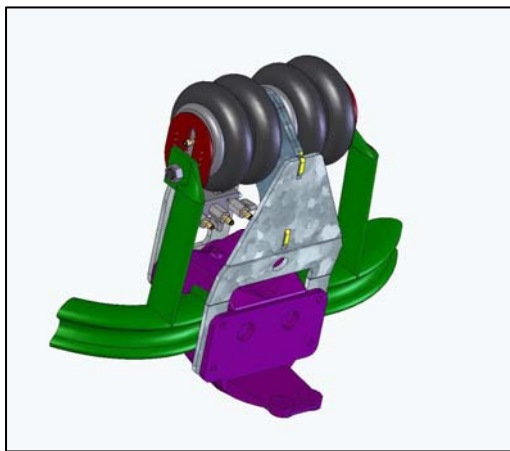

Quick Overview

The QuadraBag system consists of an inner riser bolted to the bogie and motorhome frame, and an outer riser that is bolted to the bogie pins. A special machined washer on the bogie pin aligns with machined cavities in the outer riser to align and lock the riser.

Both the inner and outer risers have a strong welded gusset. When installed these gussets align and are bolted together to form an exceptionally strong support for the four air bags.

Some owners will feel that these suggestions are too detailed but I want to convey the things I learned doing this project so that other owners will not be hesitant to add this upgrade to their coach

Step 1 - Receiving and checking the contents of the Quadra Bag kit.

The QuadraBag kit arrived in 2 boxes. Photos 1,2, & 3 show the items in the QuadraBag kit. As always, it's a good idea to assure that the kit is complete before you start the installation.



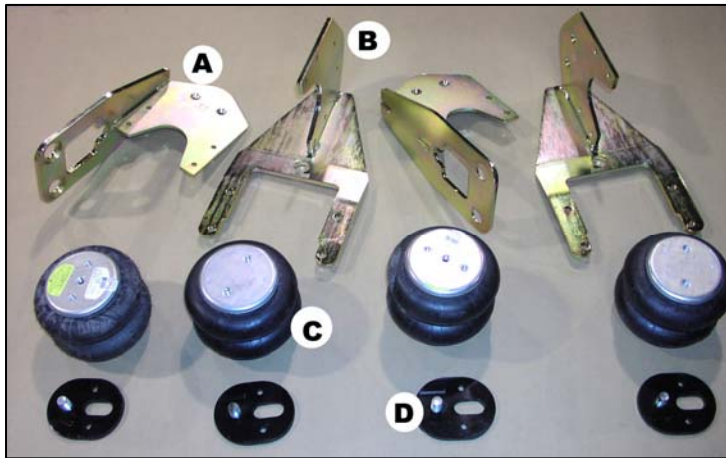

Photo 1

A – Outer riser – 2 pcs. B – Inner riser – 2 pcs.. These risers are packed as matched pairs. 1 pair in each box. C – New air bags – 4 pcs. D – Air bag risers – 4 pcs

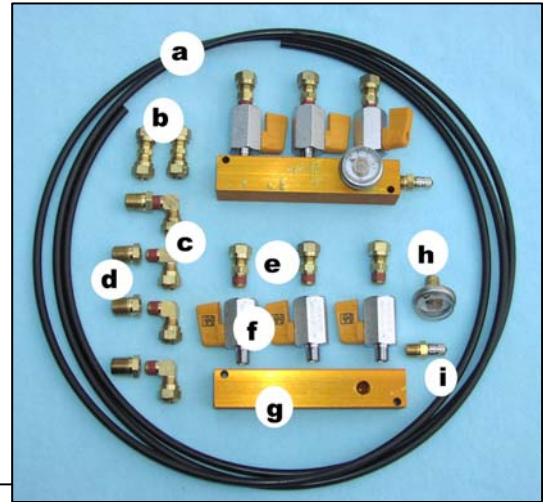

Photo 2

a – 1/4" Air hose – 9 feet. b – Air hose couplers – 2 pcs. c – Air line connector – to air bag - right angle – 4 pcs. d – Adapters to connect right angle connectors to the air bags – 4 pcs. e – Air line connector – to shut off valve – 6 pcs. f – Shut off valves – 6 pcs. g – Air manifold – 2 pcs. h – Air pressure gauge – 2 pcs. i – Schrader valve – 2 pcs.



Photo 3

Photo 3

1 – 3/8-16 Flat head Allen drive screws – air bag to risers – 8 pcs.
 2, 3, 4 – 1/2-13 grade 8 bolts – 8 pcs, 1/2 heavy flat washers – 16 pcs.,
 1/2-13 Stover (aka lock-top) nuts – 8 pcs.. These are to attach the inner riser to the motorhome frame. 5, 6 – 3/8-16 grade 8 bolts – 8 pcs, 3/8 split lock washers – 8 pcs. Used to attach the air bags to the air bag risers. 7, 8, 9 - 3/8-16 grade 8 bolts – 8 pcs, 3/8 split lock washers – 8 pcs, 3/8-16 hex nuts. Used to tie together the inner and outer risers. 10, 11 – 3/4-16 nuts – 4 pcs., 3/4 external tooth lock washers – 4 pcs. Used to space the air bag riser from the bogie arm. 12, 13 – 1-14 nut – 2 pcs, 1-14 special machined nut with shoulder – 4 pcs. Used to attach the outer riser to the bogie arm pivot pins.

Not in the kit that you will need to purchase locally are the hardware items needed to attach the air manifolds (not included because different owners choose to mount in different locations) and thread sealer.

Also, Applied GMC recommends Permatex #54540 thread sealant; this is an excellent thread sealer sold for industrial applications and is quite expensive.

An acceptable alternative is any quality thread sealant containing Teflon. Off the shelf pipe dope is not a recommended thread sealant for air pressure applications.



IMPORTANT – Read and understand the instructions that are supplied with your kit (copy attached) and these suggestions completely before proceeding with the installation. Also, it is recommended that you minimize confusion by only working on one side at a time.

Step 2 – Removal of the T-Skirt

You will need to remove your T-Skirts for easy access to the bogey and the air bag systems. Each of my T-Skirts was held on by a bolt into the bogey (9/16” wrench) and 2 screws at the top (Phillips screwdriver). See photos 4 & 5. The T-Skirt lower support was left attached to the skirt and will be removed and modified later.



Photo 4

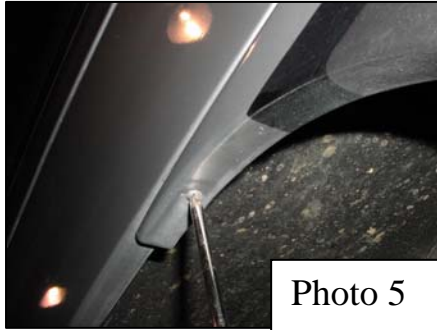

Photo 5

I suspect that these attachments may be “standard” for many coaches but will not be all that is required for all coaches, particularly those with flair skirts.

Step 3 – Apply penetrating fluid

Remove residual grease, clean, and apply penetrating fluid to all nuts that will be removed. Repeated application over 2-3 days is recommend.

Step 4 – Block the front wheels

Safety First. Block the front wheels to minimize any tendency to roll.

Step 5 – Loosen air bag and wheel nuts

With full pressure on the original bag, loosen the nuts (1 1/8” wrench) securing the bag to the bogie arms and break loose the nuts (13/16” socket or lug wrench for standard steel wheel nuts or other sizes for aluminum wheels) holding the wheels. Do not remove the nuts at this time.

Step 6 - Raise the coach and remove the wheels

Jack up the coach slightly then release the air pressure on the air bag. Insert spacers or arm support plates between the bogie and the bogie arms. See photo 6. Continue to raise the coach and put jack stands between the frame and the ground.



Photo 6

Safety First. Use at least 2 jack stands, one in front of the forward bogie arms and one behind the rear bogie arm. Each of these jack stands should have at least a 2 ton, and preferably a 3 ton rating.

Now remove the wheels.

NOTE: Because of the possible complicating effect of the exhaust pipe on the RH side it is recommended that the QuadraBag be installed first on the LH side.

Step 7 – Remove the original air bag

Cut the air line with a razor blade at the connection to the air bag. Remove the air bag nuts and remove the air bag. Save to air bag nuts. If the bag is in good condition do not discard it. Other GMC owners will want good used bags.

Step 8 – Clean area behind the bogie

Now that the air bag is out of the way you will have better access to the area at the back of the bogie and the 4 nuts that hold the bogie to the frame. Clean this area well to assure proper positioning of the inner riser. The upper nuts shown in photo 7 are the most problematic due to the limited space to work. Apply penetrating fluid to the bogie nuts and the exposed threads.



Step 9 – Replace the bogie pin nut with supplied special machined shoulder nuts

Remove the original bogie pin nuts (1 7/16" wrench or socket) and replace with the supplied special machined shoulder nuts (1 7/16" socket) and torque to 20-25 ft lbs. Note that the shoulder is facing outward as shown.

Step 10 – Replace the bolts holding the bogie to the frame

Place a jack under the bogie to support the weight of the bogie and to help hold in place any alignment spacers.

NOTE: There are 2 bolts at lower back of the bogie that bolt to the bottom of the frame. Do not remove these 2 bolts.

This step will require the assistance of a helper – someone both young and strong is recommended. Patience is helpful also. This is the only part of the installation that is, at times, frustrating. You will find that there is not a lot of room between the frame and the fuel and septic tanks but by using $\frac{3}{4}$ " sockets and extensions of various lengths that you will not have much trouble. See photo 9 for the collection of tools that we used to remove and replace these bolts.



Photo 9 “Extra” tools found useful when removing and replacing the bolts that hold the bogie to the frame

It will be necessary to “unlock” the nuts before the bolts can be removed. I found that Placing a $\frac{3}{4}$ " wrench on the nut and hitting it with a hammer while your helper kept the bolt from turning was effective.

One at a time, again to hold any alignment shims in place, remove the 4 original bolts and nuts ($\frac{3}{4}$ " wrench and socket) and replace with the supplied longer $\frac{1}{2}$ -13x2 grade 8 bolts with 2 of the supplied flat washers under the head. Check to be sure that the flat washers behind the nuts are removed. If there are alignment shims it may be necessary to use only 1 flat washer.

Removing the upper 2 nuts may be problematic due to limited access but the lower 2 nuts are readily accessible below the bogie arms.

THE 3" EXHAUST PROBLEM: Some folks recommend removing the exhaust pipe on the RH side if you have a 3" exhaust to provide more clearance to access the bolts but we found that with a bit of extra patience it is not necessary to do so

Step 11 – Install the inner riser

Double check to assure that the flat washers in the recesses in the bogie behind the nuts are all removed. The rear riser have projections on the inner side that will fit into the recesses in the bogie. Put the inner riser into place, put the $\frac{1}{2}$ " bolts into the holes, and attach with the Stover nuts. There should enough exposed threads after the inner riser is installed such that the threads will protrude through the supplied Stover nuts, if this is not the case one of the flat washers under the head of the bolt will have to be removed. We found that only 1 washer was required at each bolt.

PROBLEM ENCOUNTERED: We found that there was interference between the forward arm of the inner riser and a bracket that supports the emergency brake cable. See photo 10. We found that it was necessary to grind back the leading edge of both arms about .2" x 2" high. This problem was communicated to Jim Kanomata and he will be taking steps to modify the design to eliminate this interference.





Photo 11 Check to be sure that the brake line is not touching the inner riser.

Although we did not have a problem with the brake line hitting the inner riser others have reported this to be an issue. If this is a problem move the flat brake support bracket to the front, as shown in photo 11. In addition you may need to bend the line and/or bracket slightly as needed.

Leave the 1/2" inner riser nuts loose at this time; they will be torqued later after the outer riser is installed.



Photo 12

Step 12 – Install air connection to the air bags

Apply thread sealer and install a brass adapter (9/16" wrench) and right angle elbow (1/2" wrench) to the air bags. The air connection should be pointing up when the bag is installed. See photos 12 & 15

Step 13 – Attach air bags to the risers

Using the 3/8-16 flathead Allen drive screws in the tapered holes in the inner riser tightly attach an air bag (7/32 Allen wrench) to the inner riser. Be sure that the air connection is pointing up. Also attach an air bag to the outer riser in the same manner

Step 14 – Install outer riser

Check to assure that the inner and outer risers are a matched pair. Earlier production used

colored dots – match colors. Later production has numbers engraved into the riser gussets – match the numbers. See photo 13.



Photo 14

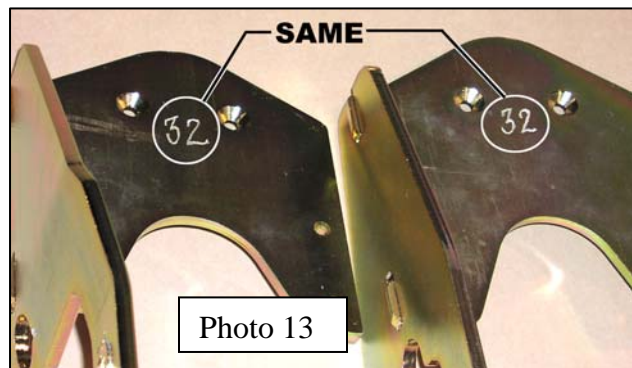

Photo 13

Put the outer riser and attached air bag in place over the machined nut on the bogie pin and mate with the inner riser. It is necessary that the shoulder on the machined bogie fit into the machined recess in the outer bogie or a false alignment will result.

Align the holes in the riser gussets and install 4 grade 8 3/8" bolts, lock washers and nuts (9/16" wrench & socket). Tighten the nuts to 45 ft lbs.

Install 1-14 nuts (1 7/16 socket) on the bogie pin and torque to 100 ft lbs.

Torque the 4 1/2-13 nuts (3/4 wrench & socket) securing the inner riser to the frame to 100 ft lbs.

Step 15 – Install air bag risers & attach to bogie arm

Attach the air bag riser plates to the air bag with 3/8 bolts & lock washers (9/16 wrench). The air bag ends are aluminum so tighten to 25 ft lbs only. Note that the air bag risers are RH & LH. Put stud on air bag riser into bogie arm, install 3/4" external tooth lockwashers and nuts (1 1/8" socket). The welded wedge on the air bag riser will determine placement. The welded wedge will align with the edge of the bogie arm. See photo 15

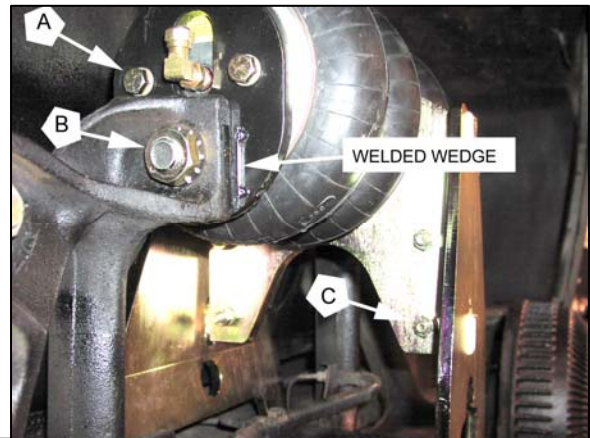
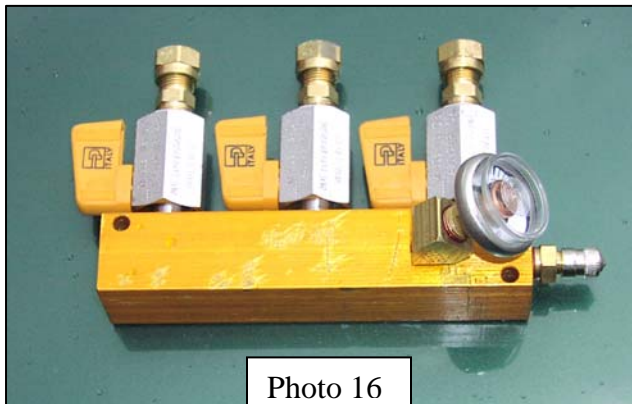

Photo 15 shows the air bag riser in place. Note that the air line connector is pointing upward. Torque A to 25 ft lbs; B to 35 ft lbs, and C to 45 ft lbs.

Step 16 – Assemble the air manifold



There are many possible ways to assemble the air manifold and I chose to assemble them as suggested by Applied GMC with the exception that I added a 1/8" 45 degree adapter to the pressure gauge (7/16 wrench, 9/16 wrench, & crescent wrench). I assume that the gauge, mounted like this, will be easier to see behind the T skirt. See photo 16.

Step 17 – Attach the air manifold and air lines

There are many places that other GMCers have attached their air manifolds with most choosing to attach it to the face of the outer riser by drilling holes in the riser and bolting it into place. I am, however, a bit concerned about debris from the wheel wiping out the gauge or an air line so I manufactured a bracket to hold the manifold between the inner and outer risers. See photo 17.

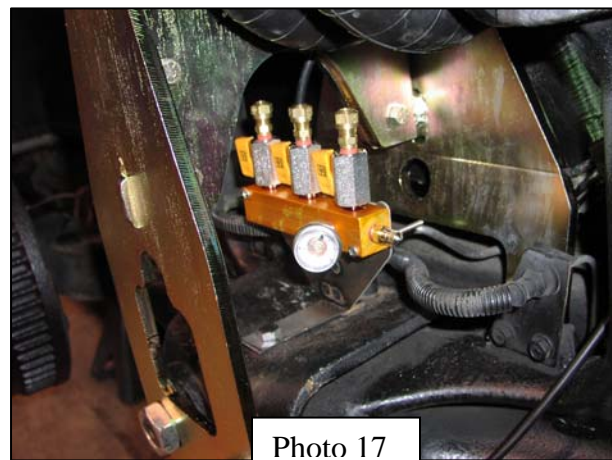

Because of the many attachment options for the air manifold Applied GMC does not include the attaching hardware in their QuadraBag kit.

Attaching the air lines couldn't be easier. Cut the original air line ends square with a razor blade, put the retainer nut and ferrule over the line, push the line into one end of the supplied air hose couplers and tighten the nut (9/16 wrench). Cut a length of the new supplied air hose as needed to run from the coupler to one of the air line connector at an air valve and attach in the same way. Repeat this process running air lines from the other air valve connectors to the connectors at the air bags.

Repeat these steps on the other side and you are essentially done. All that is left to do is put the wheels back on, put air on your new QuadraBag system, check for air leaks with soapy water, and reinstall your T skirts.

If you want to buy any spare air fitting or 1/4" line you will find them at most truck repair/parts companies.

You may want to leave off your T skirts in order to better show off your new QuadraBag setup but if you decide to reinstall your skirts then go to step 18.

Step 18 – Re-install the T-Skirts

Reinstalling the T-Skirts is the reverse of Step 2 with the exception that you will need to modify your original T-Skirt lower supports or purchase new supports. As shown in photo 18 the rubber and part of the metal will have to be modified to allow the rubber portion to pass through the opening in the outer riser.

New lower supports as shown are available for purchase in stainless steel & rubber. These are not included in the kit.



Photo 18 shows a new stainless steel lower skirt support modified to be used with the QuadraBag system and a very shabby original.

IN CONCLUSION I hope you find this information useful. Now with your QuadraBag system installed you are ready to enjoy an improved ride as well as enhanced highway safety.

DISCLAIMER:

Information presented by GMCES is intended only to communicate thoughts, ideas, opinions and procedures to and from GMC owners; there is no attempt to replace or supersede recommendations from General Motors Corporation or any other component manufacturer. All opinions expressed are those of the authors and not GMCES. Mention of any product does not constitute endorsement by GMCES. Neither the authors nor GMC Eastern States assume any responsibility for what you choose to do to your coach.

Installation instructions for Quadra Bag System
By Applied GMC/Coop Motor Works

Read this completely before starting and only work on one side at a time!

1. Block up front wheels.
2. Raise rear end with 1/4" arm support plates under both bogie arms.
3. Using jack stands, pull both wheels off.
4. Loosen nut on air bags with full air pressure, cut line with razor at bag.
5. Pull old bag off and save nuts.
6. Remove the 2 big bogie pin nut and discard the old nut.
7. Install the 2 big machined nuts with shoulder facing out and follow the service manual instructions (torque 15-20 ft lbs.) Check for excess play.
8. Remove the 4 each 1/2" bolt/nut attaching the rear bogie case to the frame. Discard the old 1/2" fastener.
9. Clean off old grease and dirt from bogie case where the rear riser bolts on. Otherwise the back mount will not bolt on properly.
10. Install the new bolt with thick washer through frame. (See Diagram)
11. Install brass reducer and right angle elbow to bags.
12. Attach air bag to the rear riser with allen wrench (2 each).
13. Install assembly to frame/bogie case (leave loose).
14. Attach air bag to the front riser with allen wrench (2 each).
15. Bring assembly to mate to the rear riser and 2 bogie pins.
16. Loosely attach the 2 bogie nuts and insert 3/8 bolts into the gussets tightly.
17. Tighten the 2 bogie nuts (100 ft lbs).
18. Tighten the 4 each 1/2" bolts with stover nut to 100 ft lbs.
19. Attach raiser plates to bags with 3/8 grade 5 bolts and lock washer.
20. Push the 3/4 stand through the bogie arm hole and use the new nut and lock washer. The welded wedge on the raiser will dictate where it will go.
21. Assemble air manifold similar to sample. Highly recommended for Air Manifold: Permatex #54540 thread sealant.

NOTE: There are 2 settings to use. Lower one gives better control and firmer ride. Higher one gives better load capacity and softer ride.

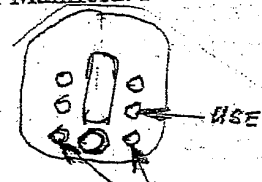

Do not use!

The bags can be inflated to 150 psi max.

NOTE: AIR BAGS HAVE ALUMINUM ENDS - MAX TORQUE 20 FT LBS.

NOTE: Check to see that the 1/8" steel brake line will clear especially when the coach is lowered all the way. If not, relocate the flat bracket on the front side of the bogie arm to gain clearance.

Complete one side at a time.

Each set must be assembled according to the marked paint spots. (blue to blue, white to white, etc)

Use only the supplied parts. do not use old parts.

See diagram.

**QUADRA BAG SYSTEM
BY APPLIED GMC &
COOPERATIVE MOTOR WORKS**

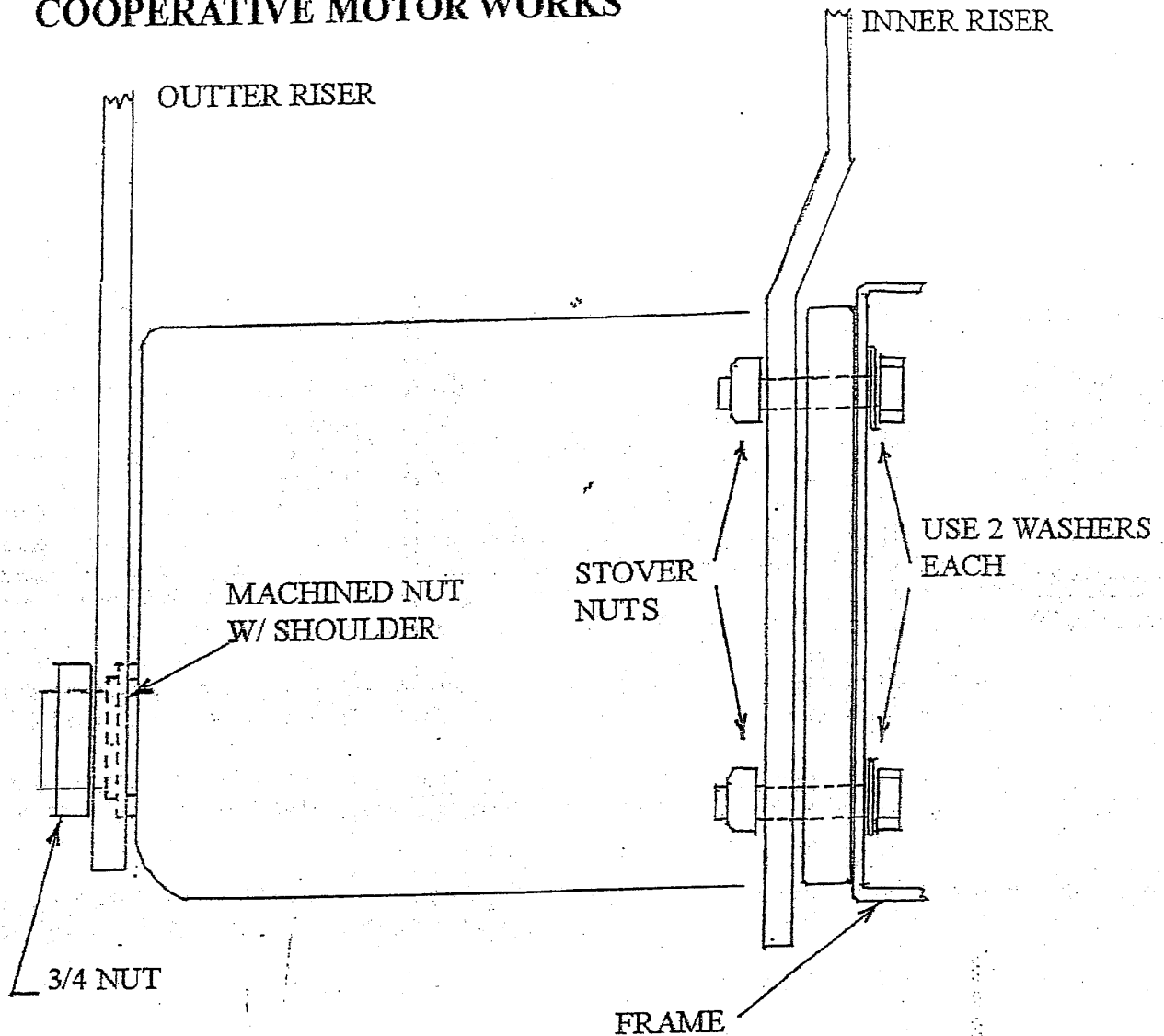

Important:

Be sure to clean the old grease & dirt off the bogie case where the inner riser meets the bogie.

Also any shims between the bogie case & frame will sometimes require a longer bolt. If so, then do not use the 2 washers.

Important:

The machined nut w/ shoulder must sit correctly in the outer (front) riser or a false setting will result. Also be sure to torque the nut to 20-25 ft. lbs. If you have any questions or concerns, please call 1 (800) 752-7502.

